



New Generation "D"

Half Round Evaporator

PRODUCT DATA & INSTALLATION

Bulletin B30-BRD-PDI-1
Part # 1110152



PRODUCT SUPPORT
web: www.b-rp.ca/bruc
email: evaps@b-rp.ca
call: 1-844-893-3222 x520

scan:



Air Defrost

For Applications 35° and Higher

Electrical Power: 115/1/60, 208-230/1/60



**INCLUDES MODELS FOR DOE & NRCAN
AWEF-COMPLIANT APPLICATIONS**

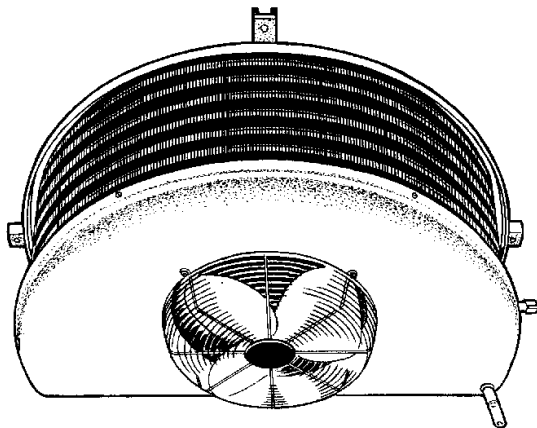

SMARTSPEED™
FAN MOTOR TECHNOLOGY
STANDARD ON ALL MODELS



CONTENTS

	Page
Nomenclature.....	2
Features & Options.....	2
Selection Data.....	2
Electrical Data.....	3
Annual Walk-In Energy Factor (AWEF) Ratings.....	3
Recommended Expansion Valve Selections.....	3
Wiring Diagram.....	4
Dimensional Data / Specifications	5
Shipping Weights.....	5
Installation Instructions.....	6 - 7
Product Support Resources: Service Parts, Troubleshooting, Warranty, etc.....	7
"As Built" Service Parts List.....	BACK

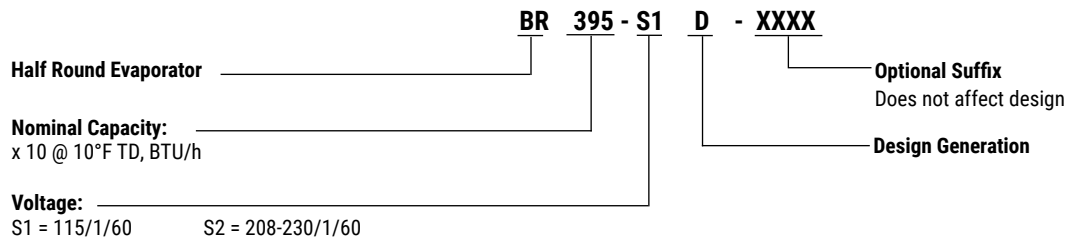

STANDARD FEATURES

- EC motors with patented SmartSpeed® Technology.
- Compatible with Low GWP Refrigerants
- Direct backwall location and minimum height provides maximum usable storage space.
- Textured heavy gauge aluminum cabinet - lightweight, doesn't show scratches.
- Rigid, slotted channel hangers simplify installation.
- Hinged drain pan for ease of cleaning and service.
- Full collar aluminum plate fins on expanded seamless copper tubes ensure optimum heat transfer efficiency.
- Fan motors are inherently protected

AVAILABLE OPTIONS

- TXV
- Liquid Line Solenoid Valve
- Mechanical Thermostat
- Painted Cabinet

SELECTION DATA

R407A R448A R449A Medium Temperature

Model BR	Qty. Fans	Evap. Temp. Selection Capacity BTU/h	Air Flow		Refrig. Charge R407A **	
		25°F (-4°C)	CFM	L/S	LB.	KG
395	1	3950	587	280	1.4	0.6
495		4950	530	250	1.9	0.9
650		6500	1080	510	2.3	1.0
840		8400	1080	510	3.3	1.5
945		9450	1200	570	3.6	1.6
1100		11000	1300	610	4.1	1.9
1270		12700	1200	570	5.3	2.4
2150	2	21500	2050	970	8.3	3.8

- Capacities at other TD within a range of 8 to 15 °F (4.4 to 8.3°C) are directly proportional to TD, or use formula: Capacity = Rated capacity ÷ 10 x TD.

** For R448A/R449A, use conversion factor 0.96

R404A R507 Medium Temperature

Model BR	Qty. Fans	Evap. Temp. Selection Capacity BTU/h	Air Flow		Refrig. Charge R404A R507	
		25°F (-4°C)	CFM	L/S	LB.	KG
395	1	3690	587	280	1.3	0.6
495		4640	530	250	1.7	0.8
650		6070	1080	510	2.1	1.0
840		7860	1080	510	3.0	1.4
945		8840	1202	570	3.3	1.5
1100		10250	1300	610	3.8	1.7
1270		11850	1200	570	4.9	2.2
2150	2	20010	2050	970	7.6	3.5

- Capacities at other TD within a range of 8 to 15 °F (4.4 to 8.3°C) are directly proportional to TD, or use formula: Capacity = Rated capacity ÷ 10 x TD.

115/1/60: Air Defrost

Model BR	FPI	FAN MOTORS					
		Qty.	Standard SMARTSPEED EC Motors				
			HP	FLA Total	Watts	MCA (A)	Max. Fuse (AMPS)
395-S1D	7	1	1/12	1.5	23	1.9	15
495-S1D		1	1/12	1.5	23	1.9	15
650-S1D		1	1/12	1.5	23	1.9	15
840-S1D		1	1/12	1.5	76	1.9	15
945-S1D		1	1/12	1.5	85	1.9	15
1100-S1D		1	1/12	1.5	85	1.9	15
1270-S1D		1	1/12	1.5	88	1.9	15
2150-S1D		2	1/12	3.0	148	3.4	15

208-230/1/60: Air Defrost

Model BR	FPI	FAN MOTORS					
		Qty.	Standard SMARTSPEED EC Motors				
			HP	FLA Total	Watts	MCA (A)	Max. Fuse (AMPS)
395-S2D	7	1	1/10	1.0	23	1.3	15
495-S2D		1	1/10	1.0	23	1.3	15
650-S2D		1	1/10	1.0	23	1.3	15
840-S2D		1	1/10	1.0	76	1.3	15
945-S2D		1	1/10	1.0	85	1.3	15
1100-S2D		1	1/10	1.0	85	1.3	15
1270-S2D		1	1/10	1.0	88	1.3	15
2150-S2D		2	1/10	2.0	148	2.3	15

AWEF RATINGS

Annual Walk-In Energy Factor Ratings

If a numerical value is listed in the table below, the following statement applies to that corresponding model: "This refrigeration system is designed and certified for use in walk-in cooler applications."

Model BR	R404A R507	R407A	R448A R449A
395	9.00	9.00	9.00
495	9.00	9.00	9.00
650	9.00	9.00	9.00
840	9.00	9.00	9.00
945	9.00	9.00	9.00
1100	9.00	9.00	9.00
1270	9.00	9.00	9.00
2150	9.00	9.00	9.00

RECOMMENDED THERMAL EXPANSION VALVE SELECTIONS

Medium Temperature Models

Model BR	TD °F	R404A	R507	R407A	R448A	R449A	
		SPORLAN		SOLENOID VALVES		SOLENOID VALVES	
		SBQSE-AA-C	SOLENOID VALVES	SBQSE-AA-C	SOLENOID VALVES	SOLENOID VALVES	
395	10	SBQSE-AA-C	3	SBQVE-AAA-C	3	3	
	15	SBQSE-AA-C	3	SBQVE-AA-C	3	3	
495	10	SBQSE-AA-C	3	SBQVE-AA-C	3	3	
	15	SBQSE-A-C	3	SBQVE-AA-C	3	3	
650	10	SBQSE-AA-C	3	SBQVE-AA-C	3	3	
	15	SBQSE-A-C	3	SBQVE-A-C	3	3	
840	10	SBQSE-A-C	3	SBQVE-AA-C	3	3	
	15	SBQSE-A-C	3	SBQVE-A-C	3	3	
945	10	SBQSE-A-C	3	SBQVE-A-C	3	3	
	15	SBQSE-B-C	5	SBQVE-A-C	3	3	
1100	10	SBQSE-A-C	3	SBQVE-A-C	3	3	
	15	SBQSE-B-C	5	SBQVE-B-C	5	5	
1270	10	SBQSE-B-C	3	SBQVE-A-C	3	3	
	15	SBQSE-C-C	5	SBQVE-B-C	5	5	
2150	10	SBQSE-C-C	5	SBQVE-B-C	5	5	
	15	SBQSE-C-C	6	SBQVE-C-C	6	6	

Above selections based on: 1) 100°F (38°C) vapor free liquid entering expansion valve, 2) 110°F (43°C) condensing temperature, 3) 10 - 15°F (5.5 - 8.3°C) evaporator TD

115/1/60, 208-230/1/60: Air Defrost Models

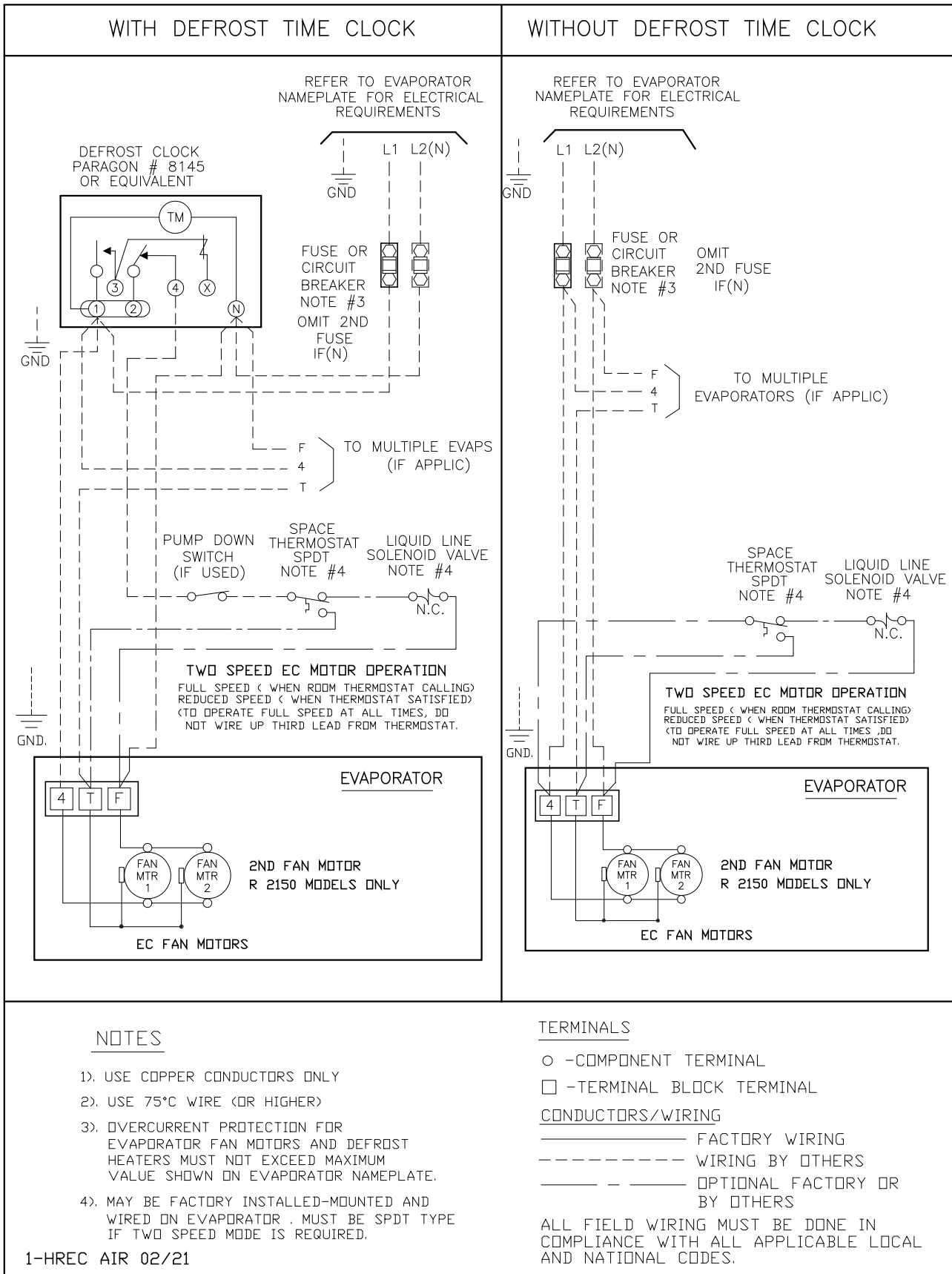

DIMENSIONAL DATA / SPECIFICATIONS

BR - HALF ROUND EVAPORATORS

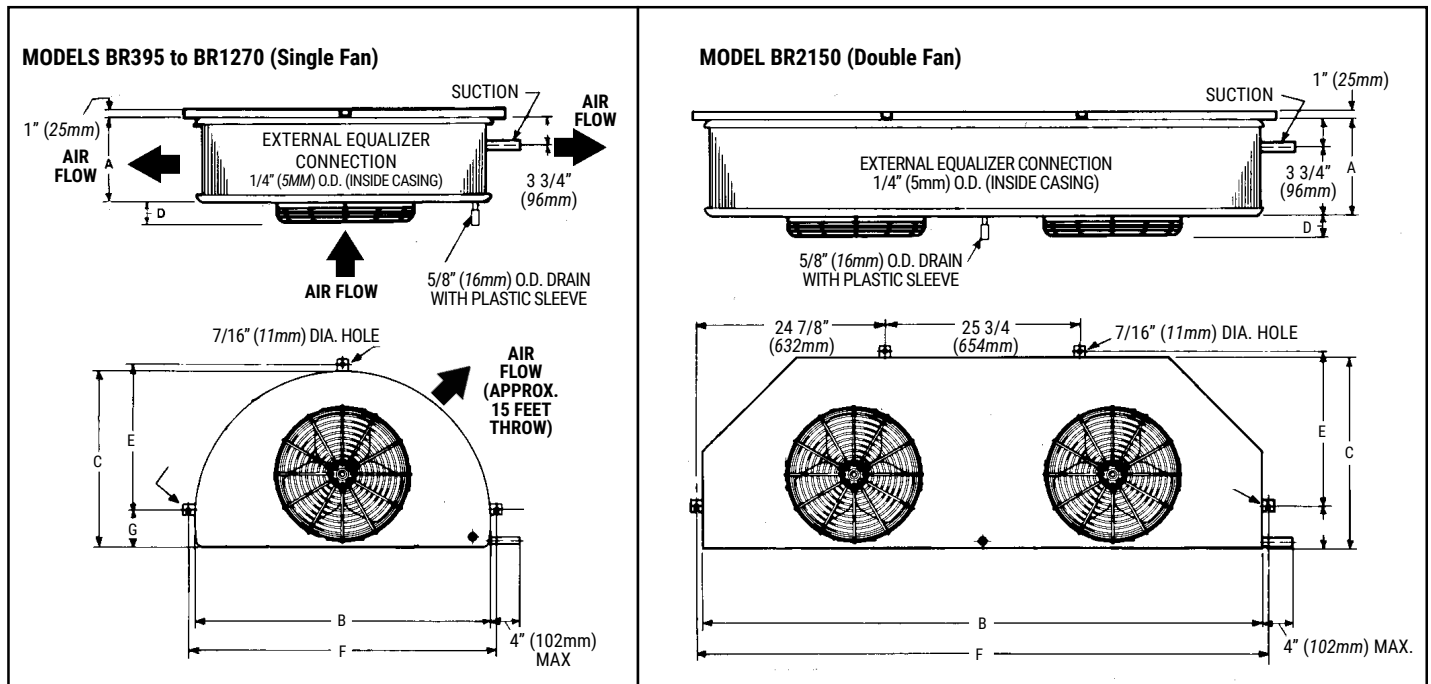

MODEL BR	NO. OF FANS	A		B		C		D		E		F		G	
		IN	mm	IN	mm	IN	mm	IN	mm	IN	mm	IN	mm	IN	mm
395	1	8 1/8	206.375	33 1/4	844.55	20 3/4	527.05	2	50.8	16 3/4	425.45	34 3/4	844.55	4 3/4	120.65
495		8 1/8	206.375	33 1/4	844.55	20 3/4	527.05	2	50.8	16 3/4	425.45	34 3/4	844.55	4 3/4	120.65
650		11 1/8	282.575	39 1/4	996.95	23 3/4	603.25	2 1/4	57.15	19 3/8	492.125	40 3/4	996.95	5 1/8	130.175
840		11 1/8	282.575	39 1/4	996.95	23 3/4	603.25	2 1/4	57.15	19 3/8	492.125	40 3/4	996.95	5 1/8	130.175
945		11 1/8	282.575	42 1/4	1073.15	25 1/4	641.35	2 1/2	63.5	20 3/8	517.525	43 3/4	1073.15	5 5/8	142.875
1100		12 5/8	320.675	42 1/4	1073.15	25 1/4	641.35	2 1/2	63.5	20 3/8	517.525	43 3/4	1073.15	5 5/8	142.875
1270		12 5/8	320.675	42 1/4	1073.15	25 1/4	641.35	2 1/2	63.5	20 3/8	517.525	43 3/4	1073.15	5 5/8	142.875
2150	2	12 5/8	320.675	74	1879.6	25 1/4	641.35	2 1/2	63.5	20 3/8	517.525	75 1/2	1879.6	5 5/8	142.875

NOTE:

5/8 (15.9mm) O.D. Drain connection on all models.

1/2 (12.7mm) Sweat TX valve connection on all models.

CONNECTIONS

MODEL BR	TUBE CONNECTION SUCTION (OD)	
	IN	mm
395	5/8	15.9
495	5/8	15.9
650	5/8	15.9
840	7/8	22.2
945	7/8	22.2
1100	7/8	22.2
1270	7/8	22.2
2150	1 1/8	28.6

DISTRIBUTOR NOZZLE SELECTION

MODEL BR	FACTORY INSTALLED NOZZLE
395	N/A
495	N/A
650	N/A
840	N/A
945	L1
1100	L1
1270	L1-1/2
2150	L2

If correct nozzle is not available, the proper orifice size can be drilled in the field using the following chart:

NOZZLE ORIFICE No.	DRILL SIZE IN
1/2	.070
3/4	.086
1	.0995
1-1/2	.120
2	.1406
2-1/2	.157
3	.172
4	.199
5	.211
6	.242
8	.266
10	.281

SHIPPING WEIGHTS

MODEL BR	APPROX. SHIPPING WEIGHT	
	lbs.	kgs
395	72	32.7
495	76	34.5
650	98	44.5
840	104	47.2
945	108	49.0
1100	114	51.7
1270	124	56.2
2150	187	84.8

INSTALLATION

The installation and start-up of evaporators should only be performed by qualified refrigeration mechanics. This equipment should be installed in accordance with all applicable codes, ordinances and local by-laws.

INSPECTION

Inspect all equipment before unpacking for visible signs of damage or loss. Check shipping list against material received to ensure shipment is complete.

IMPORTANT: Remember, you, the consignee, must make any claim necessary against the transportation company. Shipping damage or missing parts, when discovered at the outset, will prevent later unnecessary and costly delays.

If damage or loss during transport is evident, make claim to carrier, as this will be their responsibility, not the manufacturer's.

Should carton be damaged, but damage to equipment is not obvious, a claim should be filed for "concealed damage" with the carrier.

IMPORTANT: The electrical characteristics of the unit should be checked at this time to make sure they correspond to those ordered and to electrical power available at the job site.

Save all shipping papers, tags and instruction sheets for reference by installer and owner.

APPLICATION

Half Round evaporators are designed for walk-in cooler applications used with a wide range of refrigerants. For room temperatures above 35°F (2 °C) AND evaporating temperatures above 25°F (-4 °C), the air flowing through the coil will accomplish defrost.

The coil must not be exposed to any abnormal atmospheric or acidic environments. This may result in corrosion to the cabinet and possible coil failure (leaks).

LOCATION

The unit location in the room should be selected to ensure uniform air distribution throughout the entire space to be refrigerated. When installing the unit adjacent to a wall sufficient clearance (2" (50mm) minimum) must be provided to allow the hinged drain pan to be lowered for servicing the unit. Do not locate evaporators over doors. Consideration should be given to the coil location in order to minimize the piping run length to the condensing unit and floor drain.

NOTE: These units draw air through the fan and discharge air from the coil side.

EXPANSION VALVE (TXV) SELECTION

All units require the use of an externally equalized expansion valve. (A 1/4" (6 mm) O.D. equalizer line has been provided on the coil) TX valves should not be selected strictly by their nominal ton rating. (This rating is based at a specific pressure differential and entering liquid temperature). Since applications will differ it is suggested the following selection procedure be followed.

1. Determine actual evaporator capacity.
The nominal rating is based at 10°F T.D. (5.6°C) (Entering Air Temp. minus Evap. Temp.) Note that a higher/lower operating T.D. will increase / decrease this capacity rating by their direct ratio within a range of 8 to 12°F (4.4 to 8.3°C) T.D.
2. Determine the pressure drop across the valve by subtracting the evaporating pressure and distributor pressure drop from the high side liquid pressure.
The distributor pressure drop is typically in the range of 20 to 35 psig (1.4 to 2.4 bar) depending on the type of refrigerant and operating conditions.

EXPANSION VALVE (TXV) SELECTION (cont'd)

3. Estimate entering liquid temperature. Temperatures lower than 100°F (38 °C) increase valve capacity ratings. Refer to valve manufacturer's specs for details.
4. Select valve from the valve manufacturer selection charts for the appropriate refrigerant, evaporating temp and pressure drop.

For best performance, the outlet of the expansion valve should be installed directly to the distributor body for units with a factory installed distributor. If this is not possible, a straight tube up to 12 inches may be used for the connection.

Locate the expansion valve bulb on a horizontal length of suction line preferably 3 to 6 inches from the suction header. Locate the bulb at 4 or 8 clock position and insulate with a waterproof type of insulation. Clamp the bulb to ensure 100% contact of the bulb with the suction line.

After following the manufacturer's installation instructions and after the room has reached the desired temperature the valve superheat should be checked. This will confirm that the evaporator is operating properly and performing to maximum efficiency. The superheat should be around 6 (3.3 °C) to 8°F (4.4 °C) for a 10 to 12°F T.D (5.6 to 6.7 °C). Too high or low a super heat will result in unsatisfactory system performance and possible compressor problems.

NOZZLE INSTALLATION

For common applications (Medium temp. R404A/R22/ R407A/ R448A, 8 to 12°F (4.4 to 6.7°C) T.D.; the nozzle for most models has been factory installed for units with a factory installed distributor. For other applications, refer to nozzle manufacturer's selection guide. To replace a nozzle, the nozzle retainer clip (in distributor) must be removed before inserting nozzle. Re-install clip ensuring nozzle is properly in place. A small nozzle can be drilled larger using the drill size listed in table on page 5. Ensure the hole must be accurately centered and smooth. A lathe is preferred for the drilling.

MOUNTING

Refer to dimensional drawing for recommended mounting arrangements. Ensure adequate clearance is provided around the coil. The evaporators may be mounted flush with ceiling with bolts, or hanging down with rod hangers. When using rod hangers, allow adequate space between the top of the unit and the ceiling for cleaning to comply with NSF Standard 7.

When installing the unit adjacent to a wall sufficient clearance (2" (50mm) minimum) must be provided to allow the hinged drain pan to be lowered for servicing the unit. Mounting brackets with 7/16" dia holes are provided for flush mounting to the ceiling. See dimensional data.

Ensure that the ceiling is level since the drain pan has been sloped for drainage during the defrost cycle.

DRAIN LINE

The drain line should be run from the drain connection, sloping at least 1" (25 mm) per foot and should have the size at least as large as the drain connection. A trap in a warm area outside the room must be provided to allow proper draining through the tubing. Connection should be made to proper drainage facilities that comply with local regulations.

Always trap evaporator drain line individually to prevent vapor migration.

Ensure that the drain line has sufficient slope for proper drainage (prevention of ice build up/blockage in pan).

PIPING

Refrigeration grade piping must be used for all field refrigeration piping. Refrigerant line sizes are important and **may not** be the same size as the coil connections. Consult ASHRAE handbook or other similar reference book for proper line sizing. Refrigerant piping and control system should be designed to prevent possible liquid slugging (from oil or refrigerant) of the compressors on start-up after the defrost cycle. Also, it should prevent oil logging and minimize refrigerant pressure drop.

WIRING

Wire system in accordance with governing standards and local codes. Refer to data and wiring diagrams on throughout this publication for typical wiring arrangement. Electrical wiring is to be sized in accordance with minimum circuit ampacity rating (MCA). Size fuses used must not exceed the Maximum Fuse Size ratings.

For ease of identifying the proper wiring terminal, unit wiring is color coded and terminal block connections are identified.

MAINTENANCE

The unit should be periodically inspected for any dirt or ice build-up on the fin surface and cleaned if necessary with a soft whisk or brush. Also ensure coils inner (and outer) drain pans do not have any ice build-up from improper defrost operation.

SYSTEM CHECK







Before Start-Up:

1. All wiring should be in accordance with local codes.
2. Refrigerant lines should be properly sized.
3. All systems preferably include a liquid line solenoid valve at immediately up stream of the expansion valve.
4. Thorough evacuation and dehydration has been performed.
5. The suction, discharge, and receiver service valves must be open.
6. The system preferably include a liquid line filter drier moisture indicator and suction filter.
7. Pour enough water into the drain pan to allow a good check on drainage and seal the trap.

After Start-Up:

1. Check the oil level to be sure the oil charge is correct.
2. On initial start up the fans should turn on right away as they are directly powered.
3. Be sure that the expansion valve is properly set to provide the correct amount of superheat.
4. After the box temperature is close to reaching the desired temperature, the evaporator superheat must be checked and adjustment made if necessary.
In general, evaporators running with a TD of 10°F (5.6 °C) should have a superheat reading of 6° to 8°F (3.3 °C to 4.4 °C). For evaporators with another T.D., the general rule is that the superheat should be around 60 to 80% of T.D.
5. Heavy moisture loads are usually encountered when starting the system for the first time. This may cause a rapid build-up of frost on the evaporator. During the initial pull down, we suggest that the frost build-up be watched and defrosted manually as required.
6. Observe that the system goes through at least one complete DEFROST CYCLE.

PRODUCT SUPPORT RESOURCES

 <p>PRODUCT SUPPORT</p>	<p>web: www.b-rp.ca/bruc email: evaps@b-rp.ca call: 1-844-893-3222 x520</p>	 <p>WARRANTY</p>	<p>web: www.b-rp.ca/warranty email: warranty@b-rp.ca call: 1-844-893-3222 x507</p>
 <p>TROUBLESHOOTING</p>	<p>email: troubleshooting@b-rp.ca call: 1-844-893-3222 x529</p>	 <p>ORDERS</p>	<p>email: orders@b-rp.ca call: 1-844-893-3222 x501</p>
 <p>SERVICE PARTS</p>	<p>web: www.b-rp.ca/parts email: parts@b-rp.ca call: 1-844-893-3222 x520</p>	 <p>SHIPPING</p>	<p>email: shipping@b-rp.ca call: 1-844-893-3222 x503</p>

HOW CAN WE HELP YOU?

visit www.b-rp.ca/contact

Service Parts List Label To Be Attached *HERE*



DISTRIBUTED BY:

Bally Refrigeration
Morehead City, NC • Brantford, ON • Longview, TX
1-800-242-2559 ballysales@ballyrefboxes.com www.ballyrefboxes.com